

ZUBEHÖR ACCESSORIES

**Feinfilter mit
Anschlußstutzen**
*Fine filter with
connector*

SD 12,
SE 12,
SD 12 B

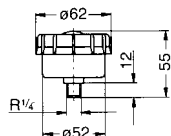

SD 20
SD 22
SD 2n
SD 2n-1
SD 3
SD 3-1

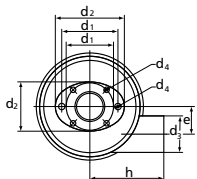

SD 24 –
SD 820

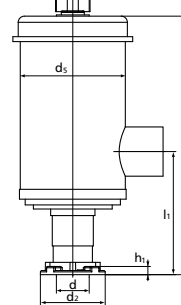
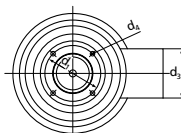

SD 90 –
SD 900
SD 120
SD 140

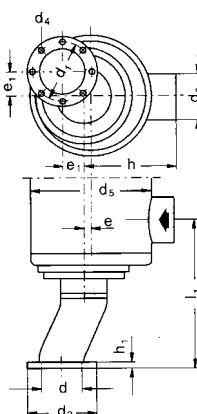

Typ Type	l	l ₁	d	d ₁	d ₂	d ₃	d ₄	d ₅	e	e ₁	h	h ₁	Artikel-Nr. Article No.
SD 12 SE 12 SD 12 B	Maße siehe Abbildung / Dimensions see illustration												001192
SD 20, SE 20 SD 22, SE 22	292	192	27	48/ 57	50/ 70	37	5,5/ 6,5	100	28	-	75	12	013300
SD 2n SE 2n SD 2n-1 SD 3-1	233	133	27	48/ 57	50/ 70	37	5,5/ 6,5	100	28	-	75	12	013301
SD 24 SE 24 SD 4n SE 4n SD 4n-1 SD 42 SE 42 SD 400 SD 420	315	150	40	68	79	60	5,5	130	-	-	110	10	011805
SD 5, SE 5 SD 52 SD 54 SD 540 SD 5200 SD 5400	383	150	50	85	100	60	7	150	-	-	110	10	011806
SD 6, SD 6-1 SD 62, SD 64 SD 600													
SD 6200 SD 6400 SD 7, SD 7-1 SD 72, SD 74 SD 740	440	175	68	110	130	100	9	190	-	-	155	12	011808
SD 80, SD 8, SD 8-1 SD 82 SD 800 SD 820													
SD 90 SD 9, SD 9-1 SD 92 SD 900	637	357	80	118	145	100	9	240	16	44	185	12	011810
SD 120 SD 140	778	493	100	139	165	132	9,5	270	16	51	210	8	011791

Ersatzpatronen zu Feinfilter Space cartridge for fine filter

Typ / Type	Artikel-Nr. / Article No.
SD 12, SE 12	001261
SD 20 - SD 22	000447
SD 2n - SD 3n	000447
SD 24 - SD 420	011999
SD 5 - SD 600	012004
SD 6200 - SD 820	012003
SD 90 - SD 900	012002
SD 120, SD 140	011998

ZUBEHÖR ACCESSORIES



Schalldämpfer mit Anschlußstutzen Silencer with connector

SD 22
SE 22

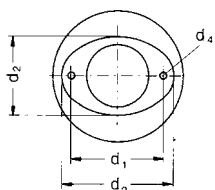

SD 2n –
SD 900
SD 120
SD 140

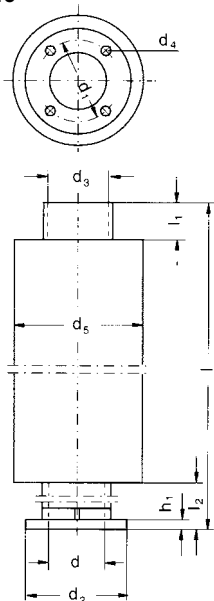

Typ Type	l	l ₁	l ₂	d	d ₁	d ₂	d ₃	d ₄	d ₅	h ₁	Schall- dämpfer Artikel- Nr. Silencer Article No.	Anschl- stutzen Artikel- Nr. Connector Article No.
SD 20 SE 20	-	-	-	-	-	-	-	-	-	-	-	-
SD 22 SE 22	606	50	150	37	58	50/70	45	5,5	90	6	000826	001451
SD 2n SE 2n SD 2n-1	606	50	150	38	58	70	45	5,5	90	6	000826	000114
SD 3 SE 3 SD 3-1	635	50	150	24	48	60	45	5,5	90	6	000826	004830
SD 24 SE 24 SD 4n SE 4n SD 4n-1 SD 42 SE 42 SD 400 SD 420	608	50	150	45	68	79	55	5,5	100	8	000813	401276
SD 5 SE 5 SD 52 SD 54 SD 540 SD 5200 SD 5400	610	50	150	55	85	100	65	7	115	10	000605	400857
SD 6 SD 6-1 SD 62 SD 64 SD 600												
SD 6200 SD 6400												
SD 7 SD 7-1 SD 72 SD 74 SD 740	612	50	150	65	110	130	80	9	120	12	000603	400027
SD 80 SD 8 SD 8-1 SD 82 SD 800 SD 820												
SD 90 SD 9 SD 9-1 SD 92 SD 900	1012	50	162	80	118	145	97	9	150	12	004174	001270
SD 120 SD 140	1100	50	205	100	139	165	112	9,5	160	8	000751	000538



ZUBEHÖR ACCESSORIES

Druckbegrenzungsventil Pressure and vacuum relief ves

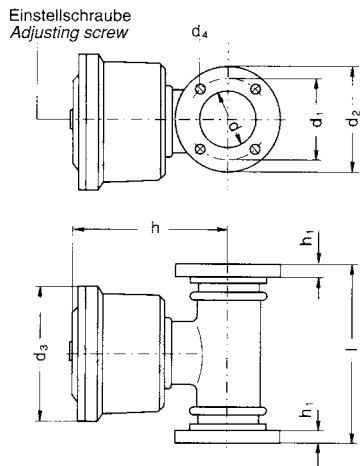

Typ Type	l	d	d ₁	d ₂	d ₃	d ₄	h	h ₁	saugseitige Drosselung Artikel-Nr. for use on vacuum side Article No.	druckseitige Drosselung Artikel-Nr. for use in pressure side Article No.
SD 2n, SE 2n SD 2n-1	-	-	-	-	-	-	-	-	-	-
SD 3, SE 3 SD 3-1	-	-	-	-	-	-	-	-	-	-
SD 24, SE 24	-	-	-	-	-	-	-	-	-	-
SD 4n, SE 4n SD 4n-1, SD 42 SE 42, SD 400	135	45	68	79	100	5,5	120	10	000592	000593
SD 420									000678	000679
SD 5, SE 5 SD 52 SD 54, SD 540 SD 5200 SD 5400	180	53	85	100	125	7	150	10	000509	000510
SD 6, SD 6-1 SD 62, SD 64 SD 600										
SD 6200 SD 6400										
SD 7, SD 7-1 SD 72, SD 74 SD 740	205	68	110	130	145	9	178	12	000662	000663
SD 80, SD 8 SD 8-1, SD 82									000442	000443
SD 800, SD 820									000662	000663
SD 90, SD 9 SD 9-1, SD 92 SD 900	225	80	118	145	180	9	188	12	001269	001268
SD 120, SD 140	248	108	139	165	180	9	202,5	30	000571	000572

Zwischenstück bei Ausführung mit Feinfilter und Druckbegrenzungs- ventil druckseitig

Intermediate tubes
necessary with fine filter
and excess pressure valve

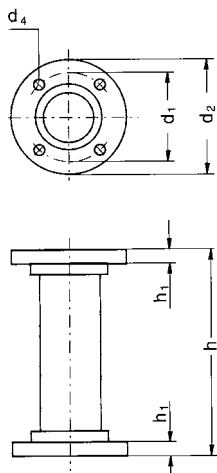

Typ / Type	d ₁	d ₂	d ₄	h	h ₁	Artikel-Nr. / Article No.
SD 2n, SE 2n SD 2n-1	-	-	-	-	-	-
SD 3, SE 3, SD 3-1	-	-	-	-	-	-
SD 24, SE 24	-	-	-	-	-	-
SD 4n, SE 4n SD 4n -1, SD 42 SE 42, SD 400 SD 420	68	79	6	140	10	001164
SD 5, SE 5, SD 52 SD 54, SD 540 SD 5200, SD 5400 SD 6, SD 6-1 SD 62, SD 64 SD 600	85	100	7	185	10	000345
SD 6200, SD 6400 SD 7, SD 7-1, SD 72 SD 74, SD 740 SD 80, SD 8, SD 8-1 SD 82, SD 800 SD 820	110	130	9	240	12	001163
SD 120, SD 140	139	165	9	270	30	000569



**Drosselklappe
Throttle valve**

**SD 22
SE 22**

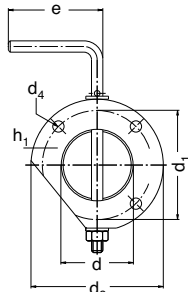

(Befestigung erfolgt beim SD 22/SE 22 nur an zwei Bohrungen.)

(Only two boreholes fixing the SD22/SE 22.)

**SD 2n –
SD 140**

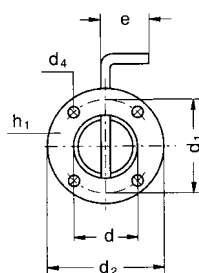

Typ / Type	d	d ₁	d ₂	d ₄	e	h ₁	Artikel-Nr. / Article No.
SD 20, SE 20	-	-	-	-	-	-	-
SD 22, SE 22	38	58	70	6	50	12	011867
SD 2n, SE 2n SD 2n-1	38	58	70	6	34	12	000111
SD 3, SE 3 SD 3-1	24	48	60	6	34	12	000112
SD 24, SE 24 SD 4n SE 4n, SD 4n-1 SD 42, SE 42 SD 400, SE 420	45	68	79	6	34	12	000105
SD 5, SE 5, SD 52 SD 54, SD 540 SD 5200, SD 5400	55	85	100	7	34	12	000373
SD 6, SD 6-1 SD 62, SD 64 SD 600							
SD 6200, SD 6400 SD 7, SD 7-1 SD 72 SD 74, SD 740 SD 80, SD 8 SD 8-1 SD 82, SD 800 SD 820	65	110	130	9	50	12	000559
SD 90, SD 9 SD 9-1, SD 92 SD 900	80	118	145	9	70	12	001271
SD 120, SD 140	98	139	165	9	100	23	000738

**Schutzgitter
Wire mesh guards**

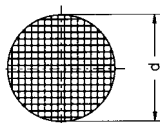

Typ Type	d	Maschenweite 0,32 Artikel-Nr. Mash width 0,32 Article No.	Maschenweite 8 Artikel-Nr. Mash width 8 Article No.
SD 20, SE 20	33	008687	008688
SD 22, SE 22	40	008689	008690
SD 2n, SE 2n SD 2n-1, SD 3 SE 3, SD 3-1	70	000460	000464
SD 24, SE 24 SD 4n, SD 4n-1 SD 42, SE 42 SD 400, SD 420	85	000461	000465
SD 5, SE 5, SD 52 SD 54, SD 540 SD 5200, SD 5400 SD 6, SD 6-1, SD 62 SD 64, SD 600	113	000462	000466
SD 6200, SD 6400 SD 7, SD 7-1, SD 72 SD 74, SD 740 SD 80, SD 8, SD 8-1 SD 82, SD 800 SD 820	133	000463	000467
SD 90, SD 9, SD 9-1 SD 92, SD 900	148	001319	001320
SD 120, SD 140	155	000575	000577



ZUBEHÖR ACCESSORIES

Gewindeflansch Threaded flanges

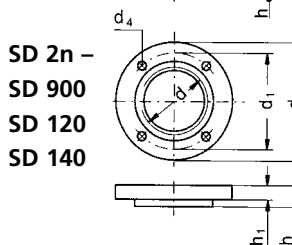
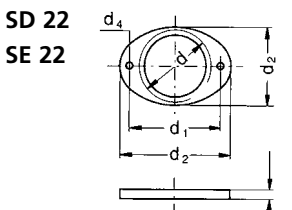
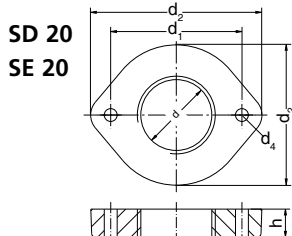

Typ Type	d	d ₁	d ₂	d ₄	h	h ₁	Artikel-Nr. Article No.
SD 20, SE 20	G1" x 12	56	60/73	5,5	12	-	001462
SD 22, SE 22	G1 1/4" x 12	58	50/70	5,5	12	-	001452
SD 2n, SE 2n SD 2n-1	G1 1/4" x 10	58	70	5,5	10	10	000109
SD 3, SE 3, SD 3-1	G3/4" x 10	48	60	5,5	10	10	000110
SD 24, SE 24, SD 4n SE 4n, SD 4n-1 SD 42, SE 42 SD 400, SE 420	G1 1/2" x 15	68	79	6	15	10	000103
SD 5, SE 5, SD 52 SD 54, SD 540 SD 5200, SD 5400 SD 6, SD 6-1 SD 62, SD 64 SD 600	G2" x 15	85	100	7	15	10	000372
SD 6200, SD 6400 SD 7, SD 7-1, SD 72 SD 74, SD 740 SD 80, SD 8, SD 8-1 SD 82, SD 800 SD 820	G2 1/2" x 20	110	130	9	20	12	000439
SD 90, SD 9 SD 9-1, SD 92 SD 900	G3" x 20	118	145	9	20	12	001272
SD 120, SD 140	G4" x 30	139	165	9	30	-	007376

Schweißflansch Welding flanges

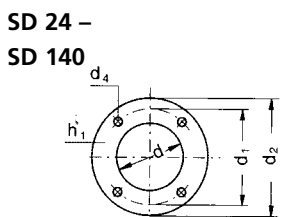
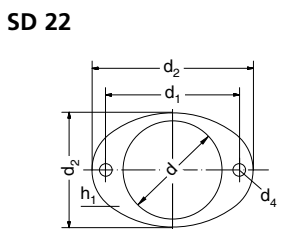
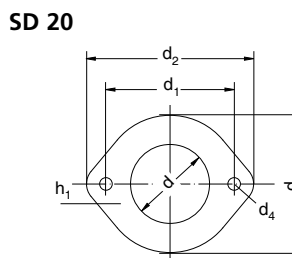

Typ Type	d	d ₁	d ₂	d ₄	h ₁	Artikel-Nr. Article No.
SD 20, SE 20	34,5	56	60/73	5,5	6	011928
SD 22, SE 22	43	58	50/70	5,5	6	011929
SD 2n, SE 2n SD 2n-1	38	58	70	5,5	6	011897
SD 3, SE 3 SD 3-1	24	48	60	5,5	6	011896
SD 24, SE 24 SD 4n SE 4n, SD 4n-1 SD 42, SE 42 SD 400, SE 420	49	68	79	5,5	6	011898
SD 5, SE 5, SD 52 SD 54, SD 540 SD 5200, SD 5400 SD 6, SD 6-1 SD 62, SD 64 SD 600	61	85	100	7	6	011902
SD 6200, SD 6400 SD 7, SD 7-1 SD 72 SD 74, SD 740 SD 80, SD 8 SD 8-1 SD 82, SD 800 SD 820	76,5	110	130	9	6	011906
SD 90, SD 9 SD 9-1, SD 92 SD 900	90	118	145	9	6	011909
SD 120, SD 140	115,5	139	165	9,5	6	011912

ZUBEHÖR ACCESSORIES



Anschlußstutzen Connectors

SD 12
SE 12
SD 12 B

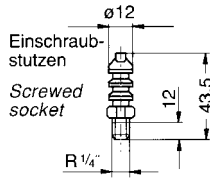

SD 20
SE 20
SD 22
SE 22

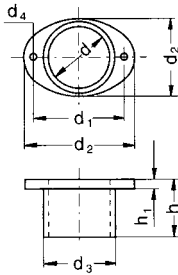

SD 2n –
SD 900
SD 120
SD 140

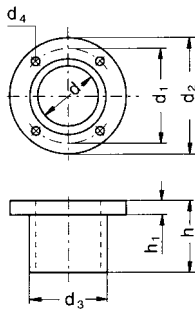

Typ Type	d	d ₁	d ₂	d ₃	d ₄	h	h ₁	Artikel-Nr. Article No.
SD 12 SE 12 SD 12 B	Maße siehe Abbildung / Dimensions see illustration							001193
SD 20 SE 20	30	56	60/73	41	5,5	35	6	000301
SD 22 SE 22	37	58	50/70	45	5,5	35	6	001451
SD 2n SE 2n SD 2n-1	38	58	70	45	5,5	35	6	000114
SD 3 SE 3 SD 3-1	24	48	60	30	5,5	35	6	000115
SD 24 SE 24 SD 4n SE 4n SD 4n-1 SD 42 SE 42 SD 400 SD 420	45	68	79	54	5,5	50	8	401276
SD 5 SE 5 SD 52 SD 54 SD 540 SD 5200 SD 5400	55	85	100	65	7	50	10	400857
SD 6 SD 6-1 SD 62 SD 64 SD 600								
SD 6200 SD 6400 SD 7 SD 7-1 SD 72 SD 74 SD 740 SD 80 SD 8 SD 8-1 SD 82 SD 800 SD 820	65	110	130	80	9	60	12	400027
SD 90 SD 9 SD 9-1 SD 92 SD 900	81	118	145	97	9	60	12	001270
SD 120 SD 140	100	139	165	109	9	100	8	000538